

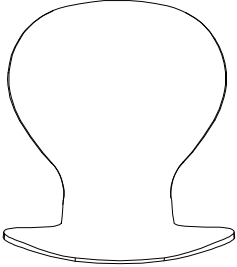

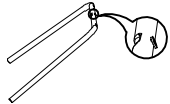

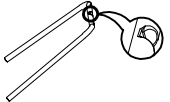





Item Name Fusion bentwood chair /Schack chair  
 ART NO.: 52115/52116/52117/52118/52119/100119/100120

# ASSEMBLY INSTRUCTION



NO.	PARTS	Q'TY
A		1
B		1
C		1
D		1
1	 M6	9
2	 4x64x25mm	1
3	 5/8"	4
4	 M6x15mm	1
5	 M6x32mm	4
6	 M6x18mm	4
7	 5/8"	4
8	 $\varnothing 17 * 6.5 \text{mm}$	4

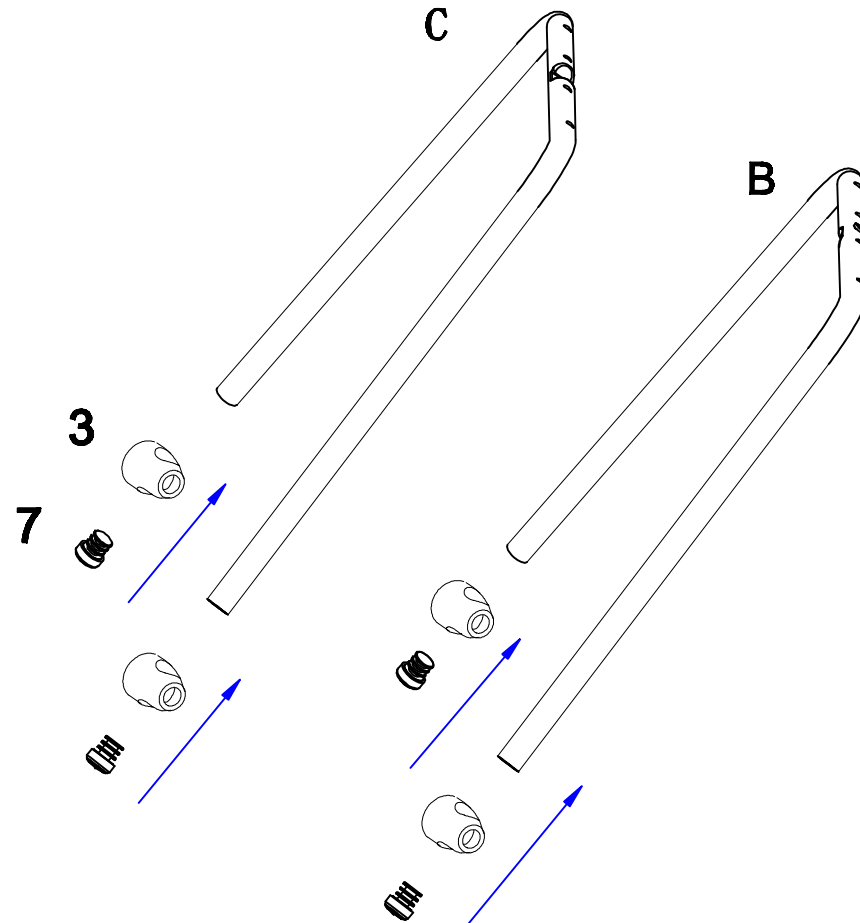

**STEP 1**

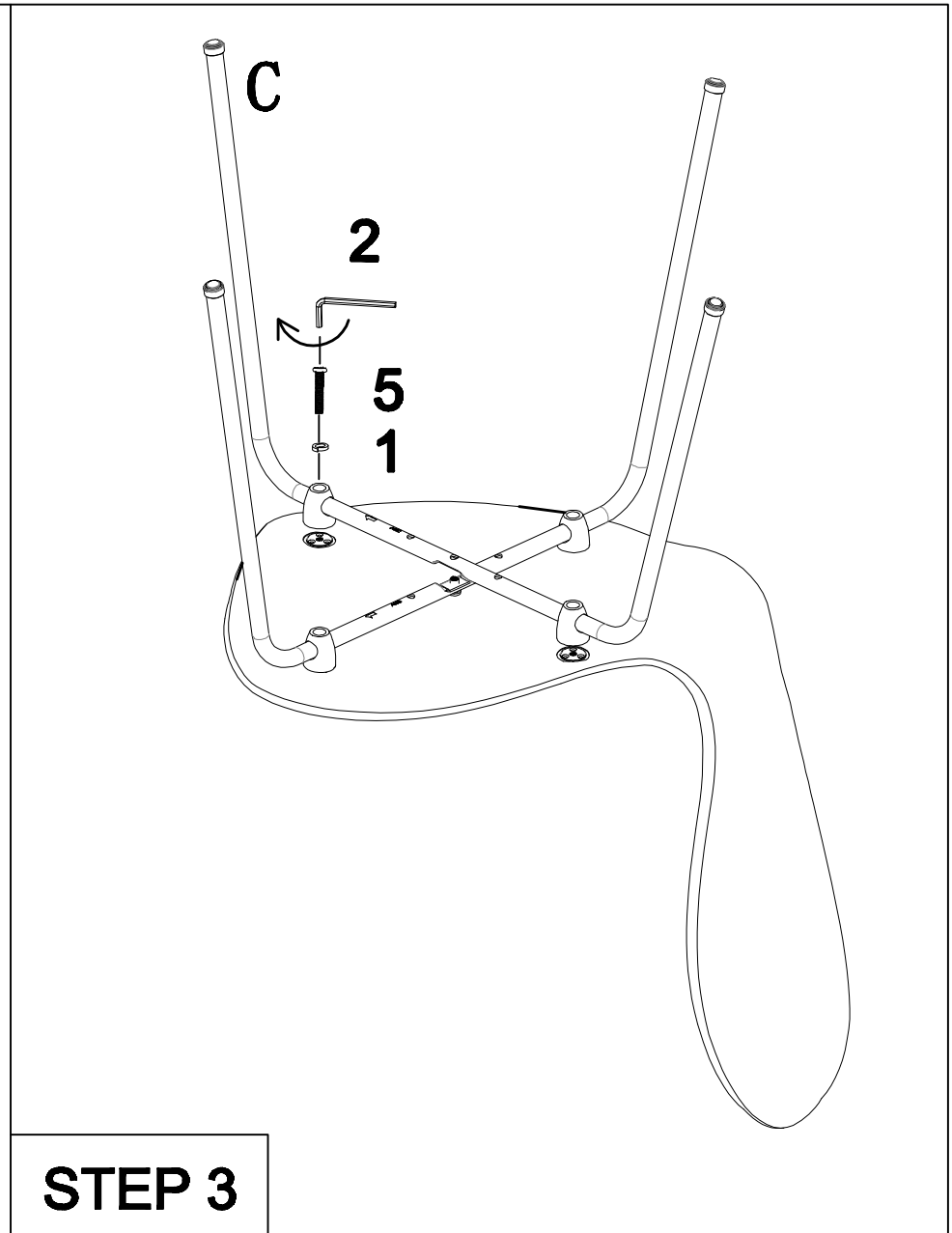
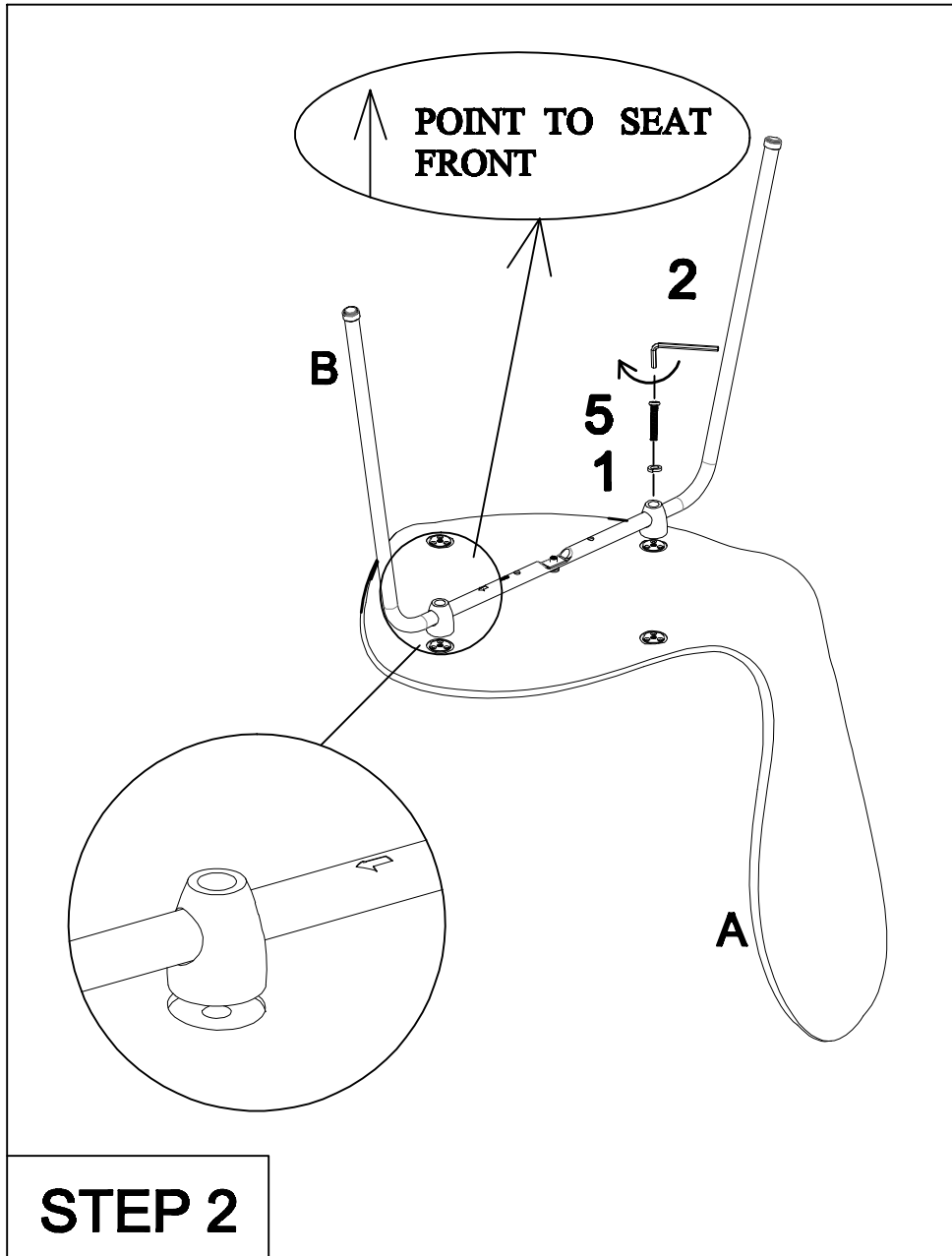

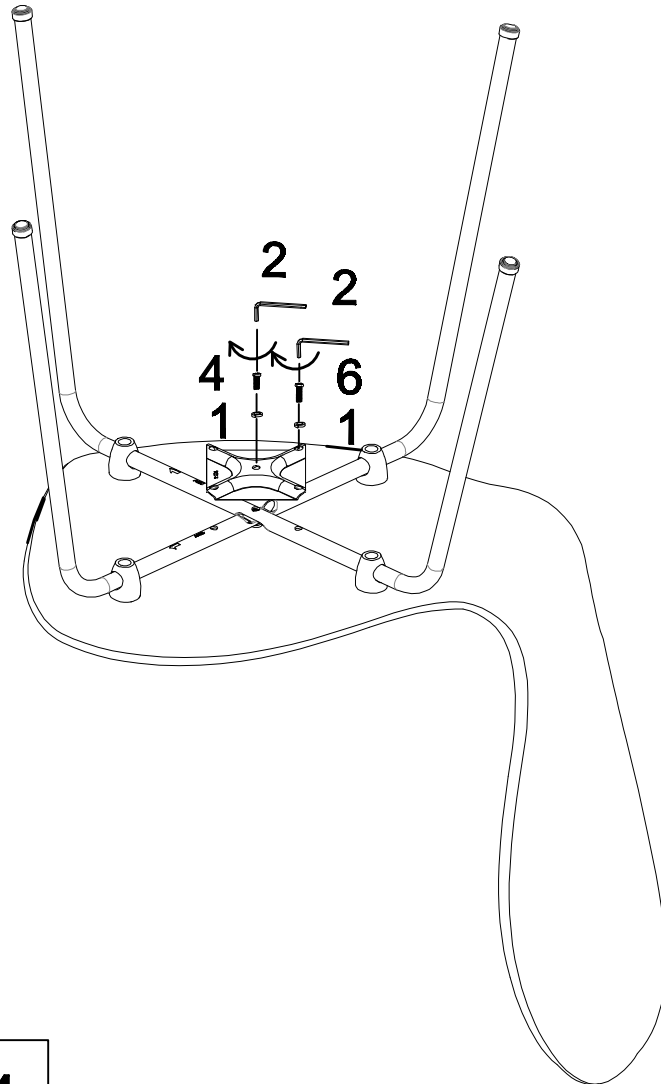

**STEP 4**

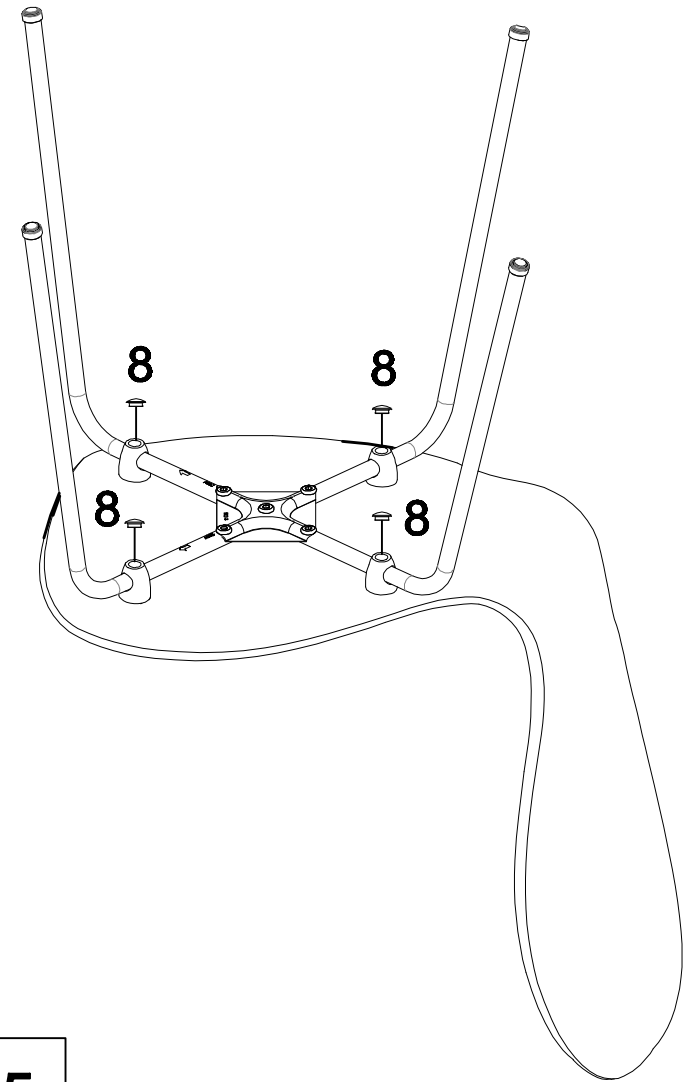

**STEP 5**

**Item Name** Fusion bentwood chair /Schack chair  
**ART NO.:** 52115/52116/52117/52118/52119/100119/100120

# ASSEMBLY INSTRUCTION

**Rowico**  
INTERNATIONAL

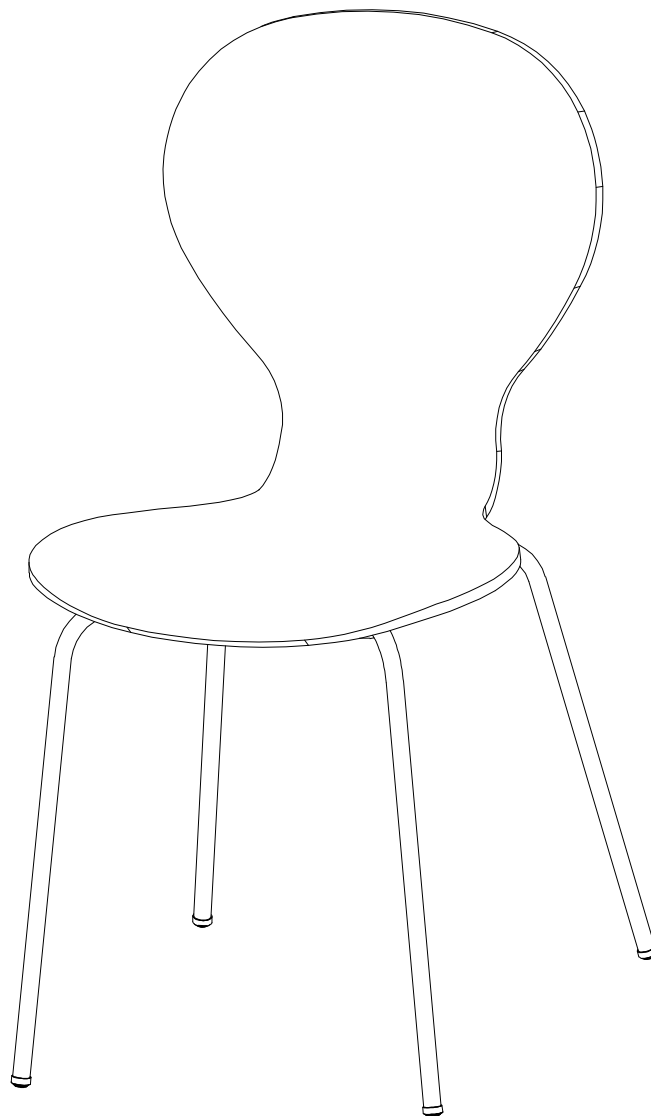

**STEP 6**