

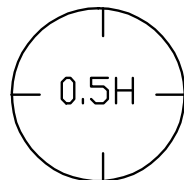

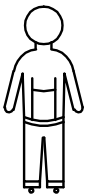

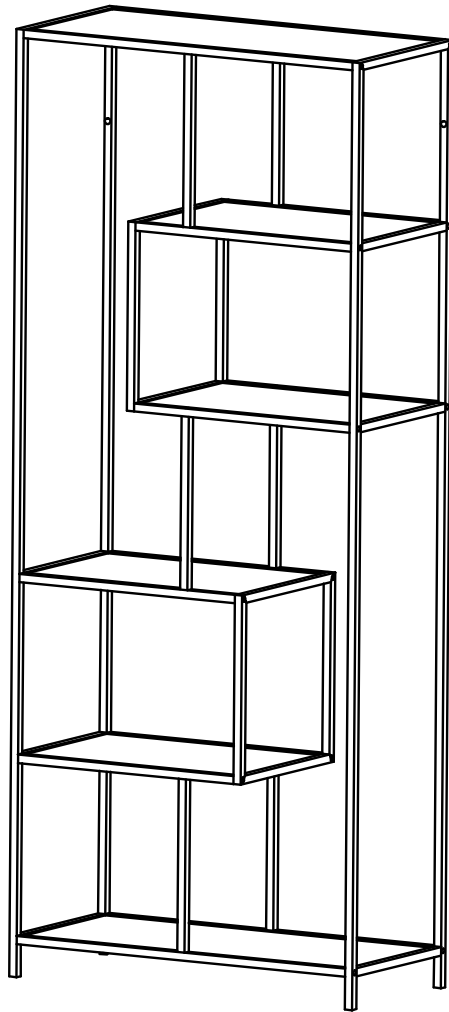

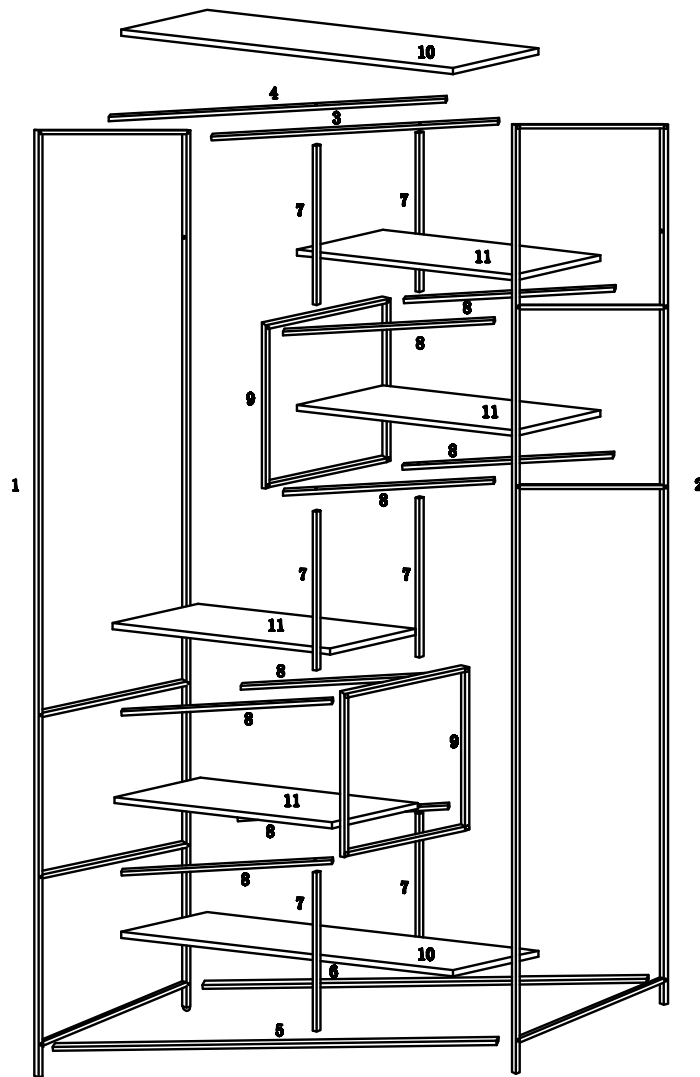

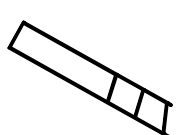
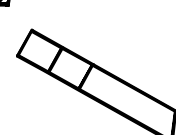



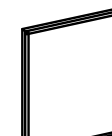

Seaford





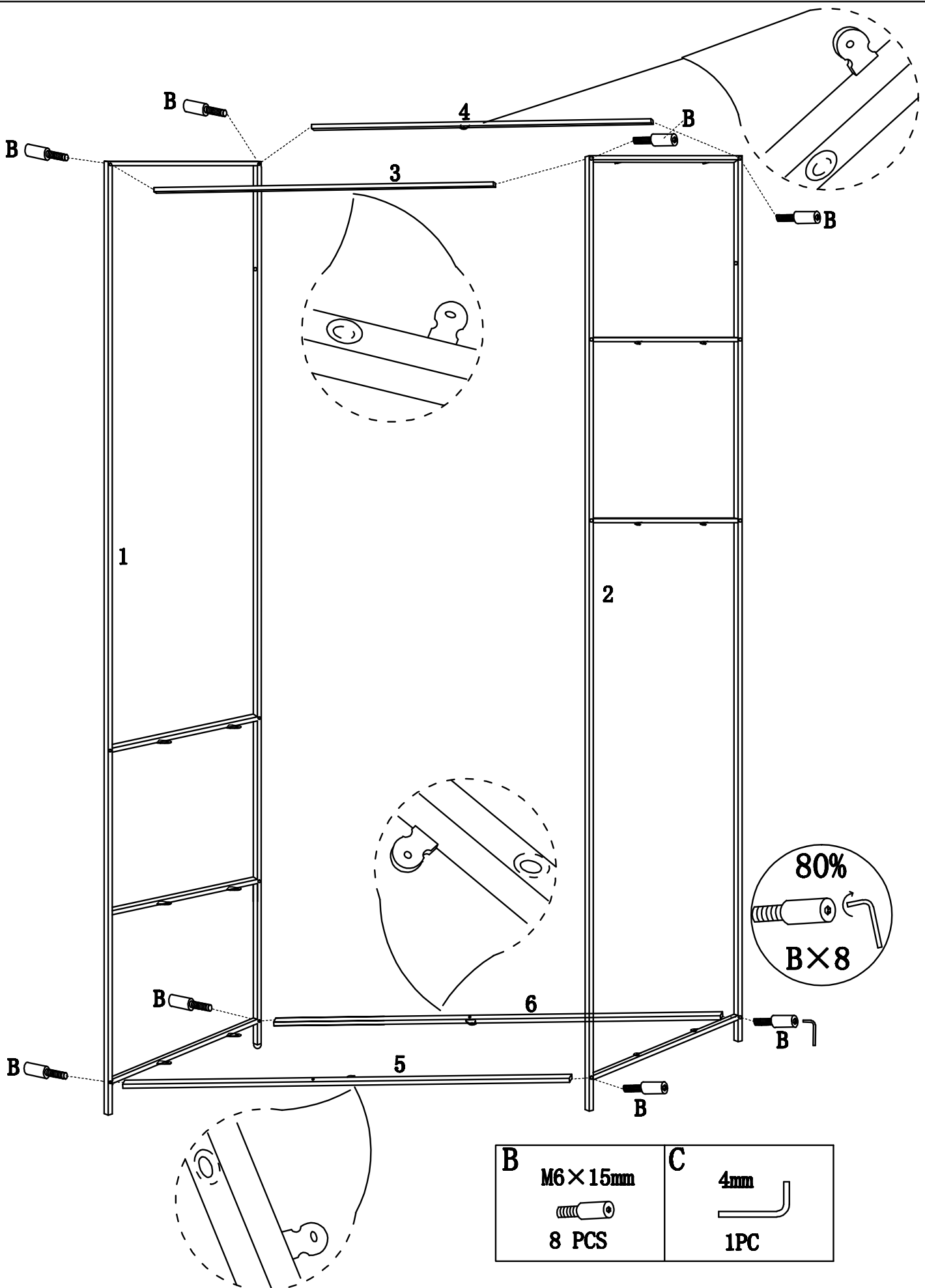

1  1PC	2  1PC	3  1PC	4  1PC	5  1PC
6  1PC	7  6PCS	8  8PCS	9  2PCS	10  2PCS
11  4PCS	A M4×10mm  28PCS	B M6×15mm  36PCS	C 4mm  1PC	

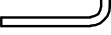

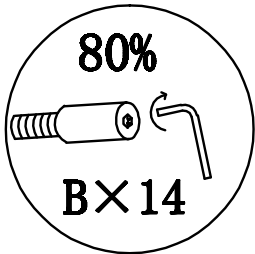
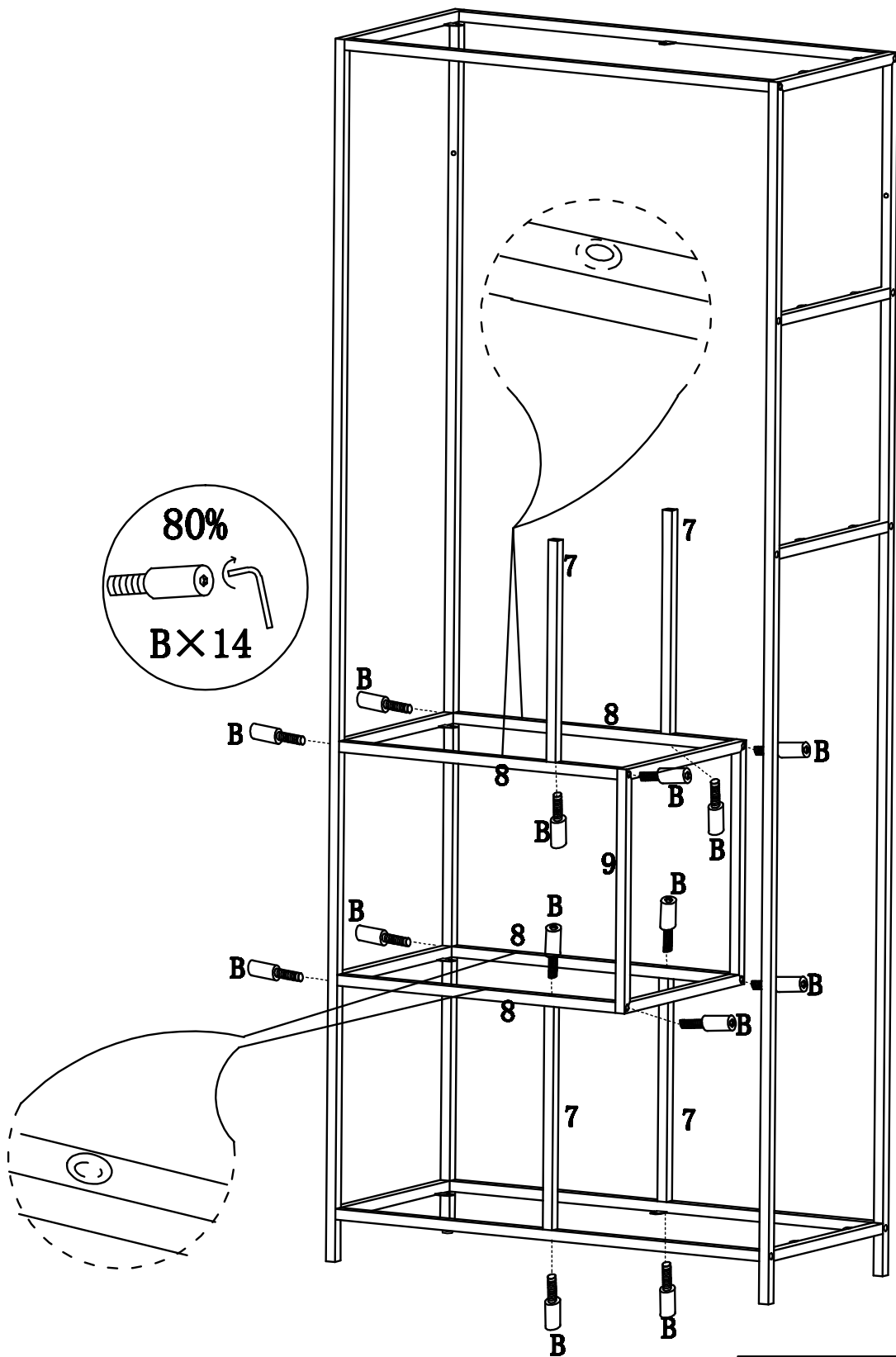

B	M6×15mm	C	4mm
			
	8 PCS		1PC

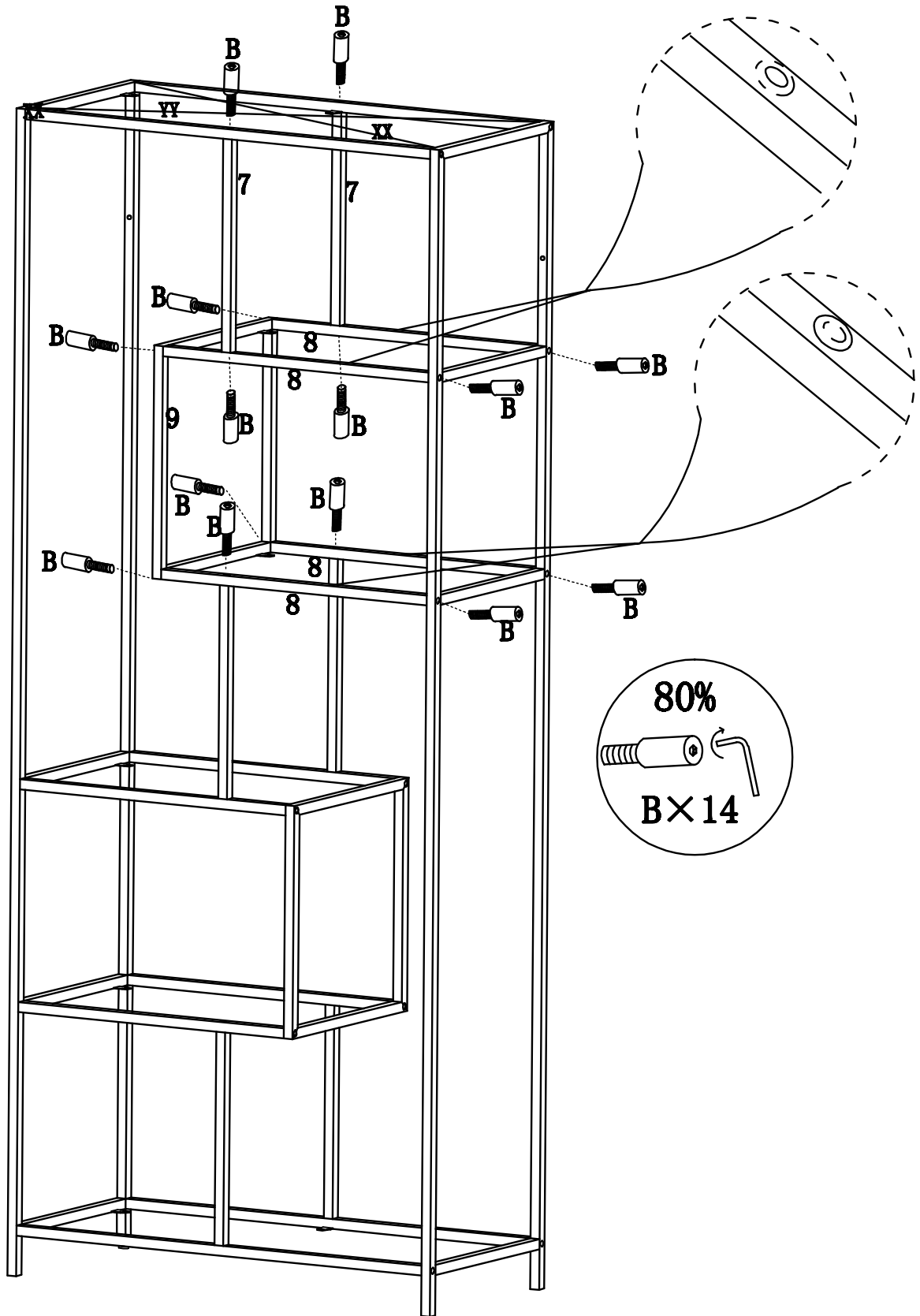

<p>B</p> <p>M6 × 15mm</p>  <p>14 PCS</p>	<p>C</p> <p>4mm</p>  <p>1PC</p>
--	---



<p>B</p> <p>M6 × 15mm</p>  <p>14 PCS</p>	<p>C</p> <p>4mm</p>  <p>1PC</p>
--	--

