

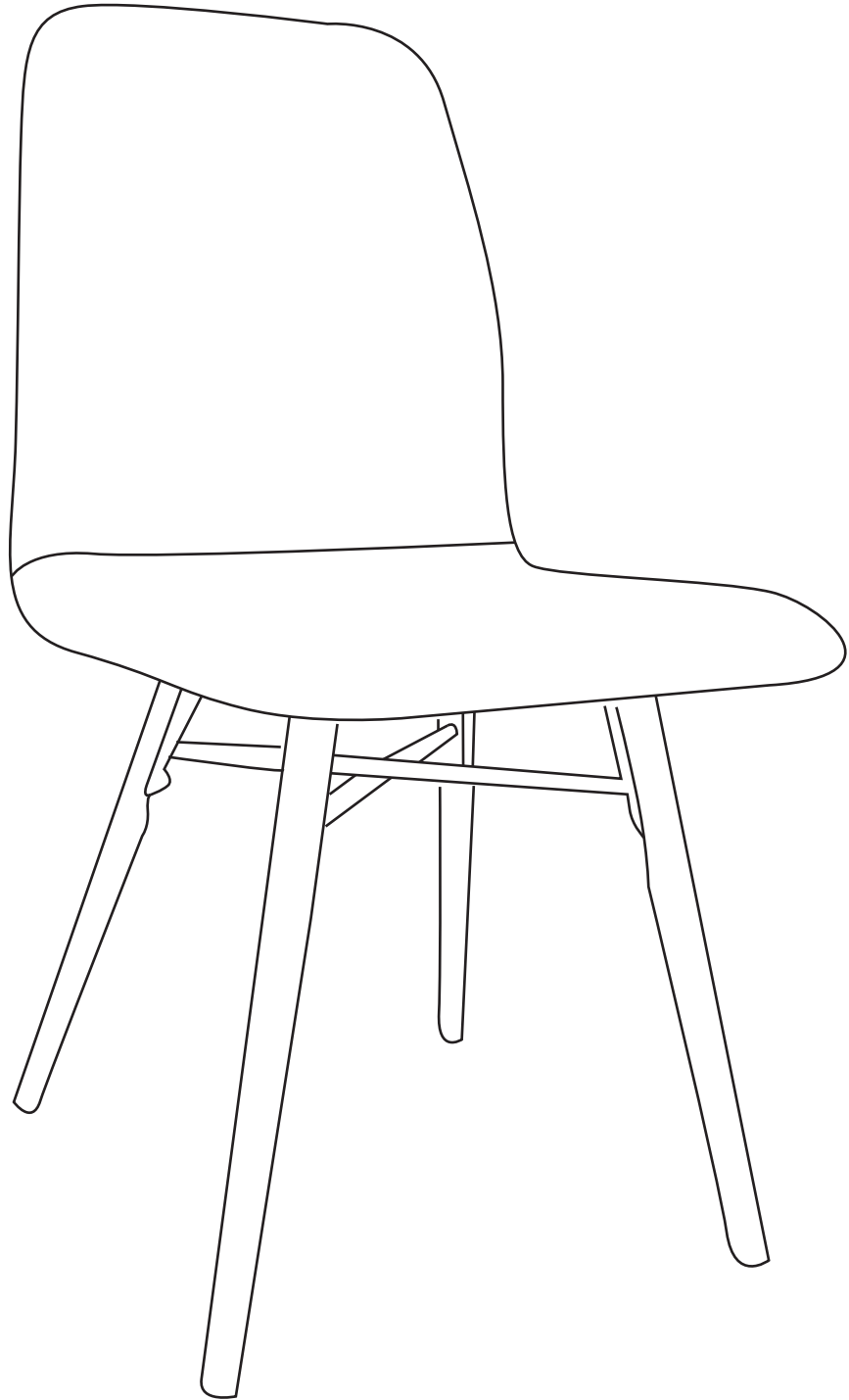









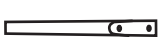

Amanda





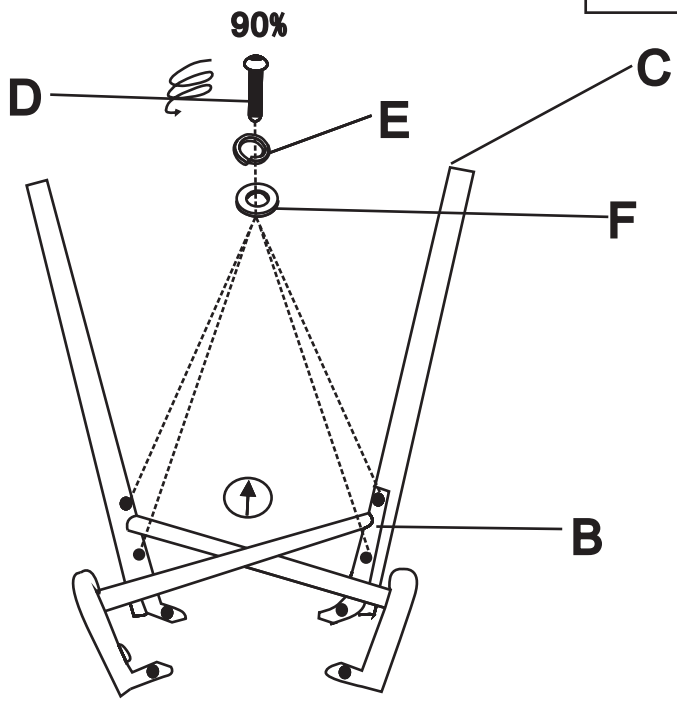

AX1 	BX1 	CX4 	DX12  M6*20	EX8  M6	FX12  6*16*1	GX1 	HX4 
--	---	---	---	---	--	---	---

1

Dx4  M6*20	EX4  M6	FX4  6X16X1	GX1 
--	---	---	---



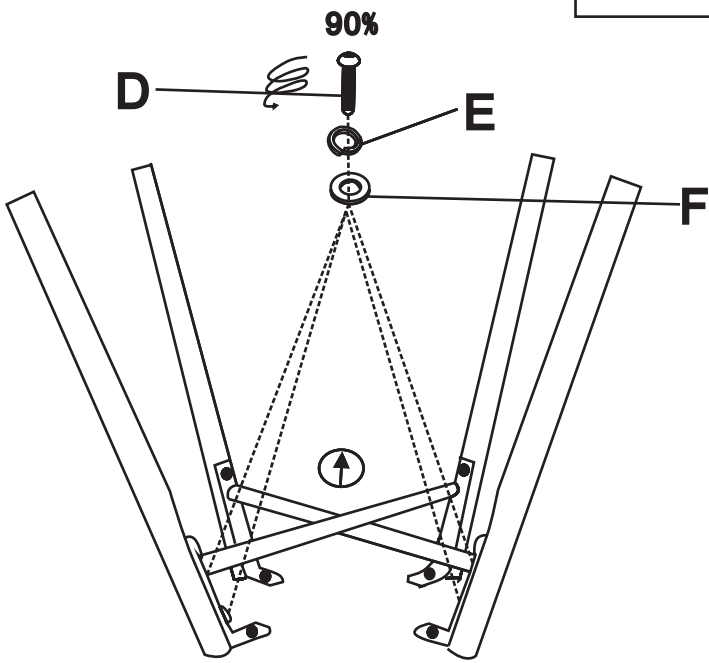

2

Dx4  M6*20	EX4  M6	FX4  6X16X1	GX1 
--	---	---	---



3

DX4  M6*20	FX4  6X16X1	GX1 
---	---	---

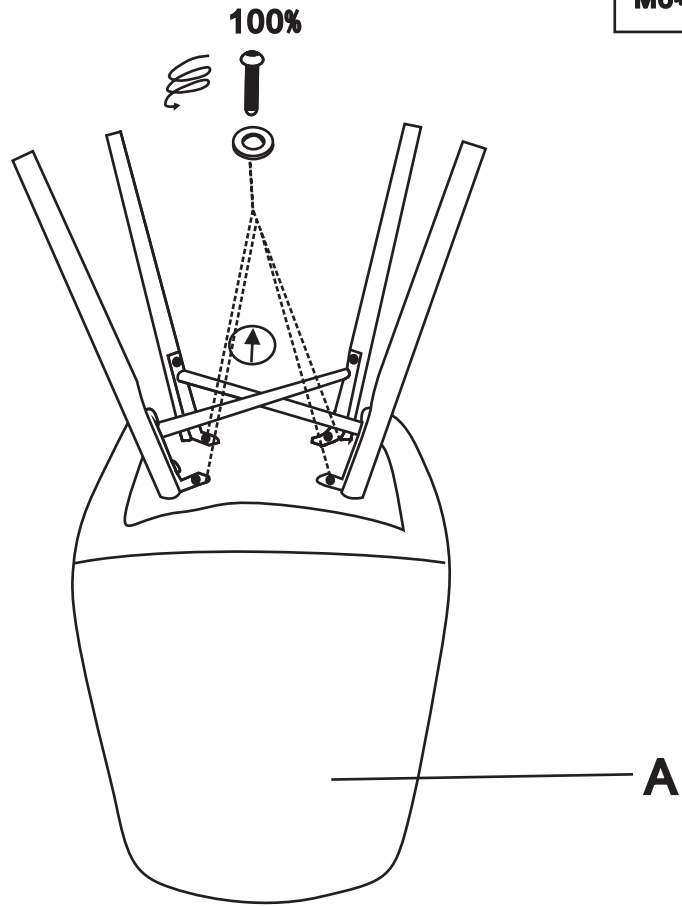

4

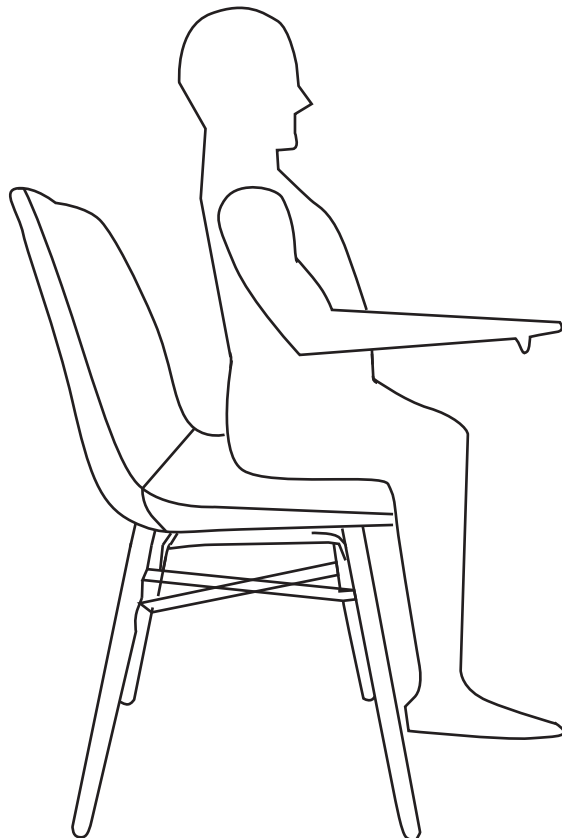

5

HX4

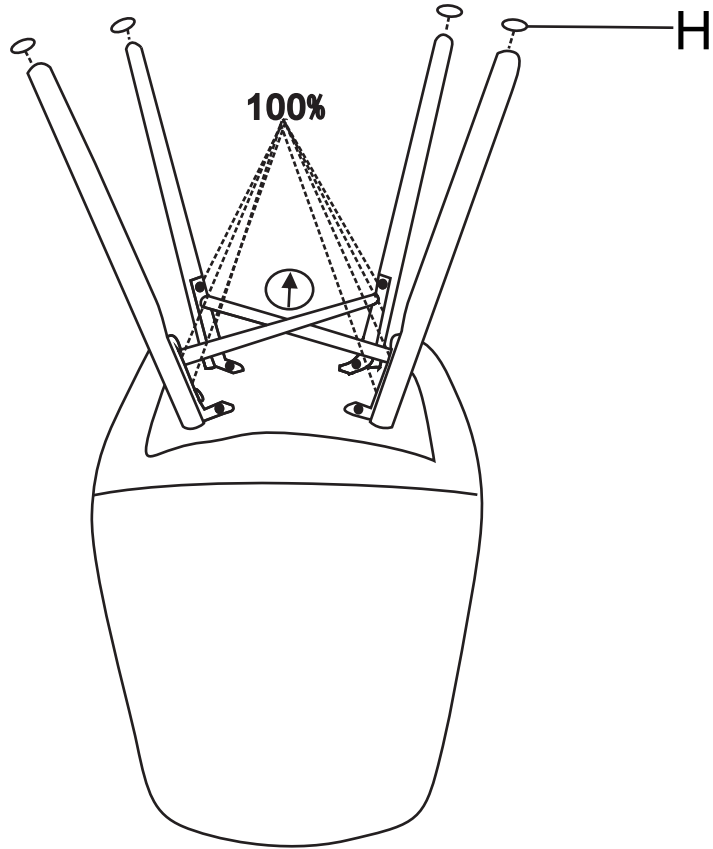

6

