

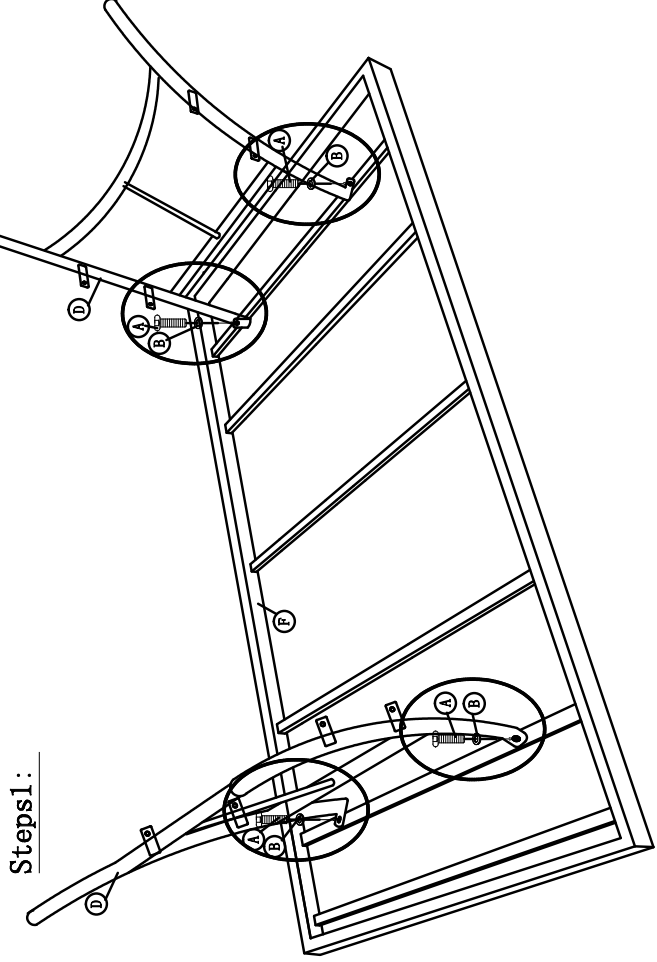





# Assembling Instruction

Item No.:98104



|   |  |    |
|---|--|----|
| A | <br>M6*20mm | 12 |
| B |             | 4  |
| C |             | 1  |
| D |            | 2  |
| E |           | 2  |
| F |           | 1  |

